

ELEMENTS OF DRINK DESIGN

Much like a well-designed object, a well-crafted cocktail takes into account the contributions of each element and how they play against each other. Balance and tension, comfort and elevation, the nuances of technique and ingredient make each cocktail unique.

The Elements of a Cocktail

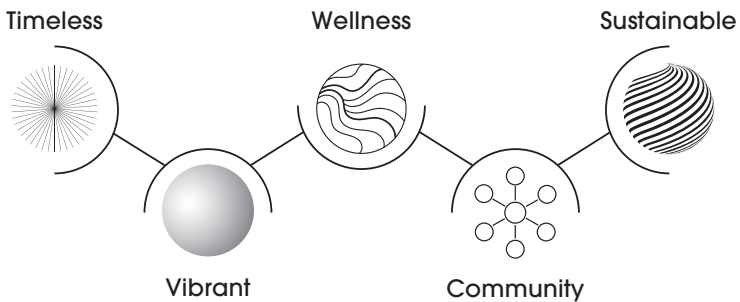

Cocktails



BUILD YOUR OWN HIGHBALL 14

Choose your Spirit:

VODKA

Tito's Handmade
Belvedere Organic
Grey Goose

TEQUILA

Herradura Silver
Casamigos Reposado
Milagro Añejo

BOURBON

Bulleit
Maker's Mark
Woodford Reserve

Choose your Mixer:

Q Club Soda
Owen's American Tonic
Q Ginger Ale
Owen's Ginger Beer

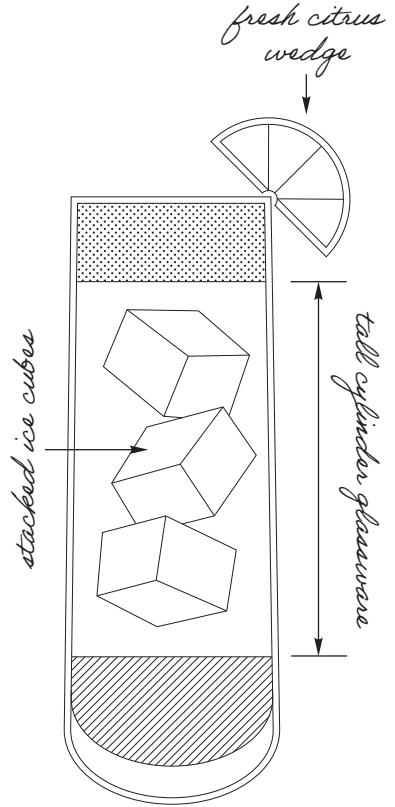

composed of an alcoholic base spirit and a larger proportion of a non-alcoholic mixer.



AMERICANO HIGHBALL 16

Campari, Antica Formula Sweet
Vermouth, Q Club Soda



OF ALL THINGS 15

21 Seeds Grapefruit Hibiscus
Tequila, Aperol, Barmalade
Grapefruit-Elderflower,
fresh lime, rhubarb bitters,
Lunetta Prosecco



*edible micro
flowers*

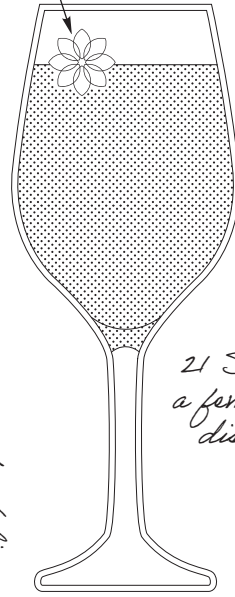

*21 Seeds is
a female-led
distillery*

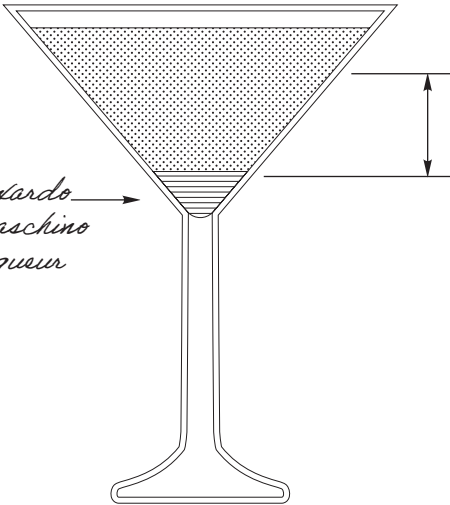

fresh lime juice

*Luxardo
Maraschino
Liqueur*

ELEMENT KEY



Timeless



Vibrant



Wellness



Community



Sustainable



THE LAST WORD MARTINI 16

Hendrick's Gin, green chartreuse,
Luxardo Maraschino Liqueur,
fresh lime



Make it smoky with Dos Hombres Mezcal 18

Cocktails

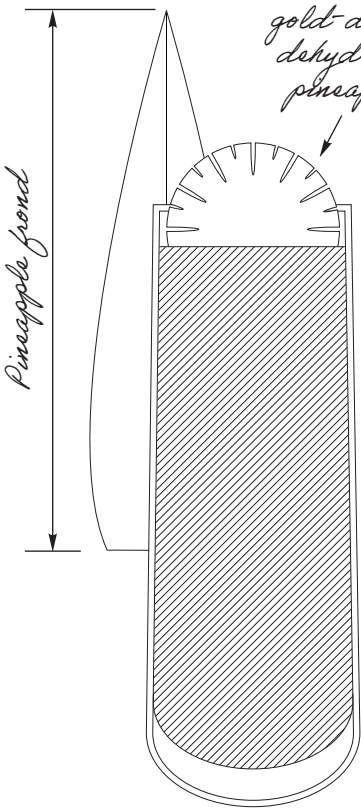

*gold-dusted
dehydrated
pineapple*

Pineapple frond

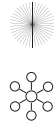

JUNGLE BIRD 15



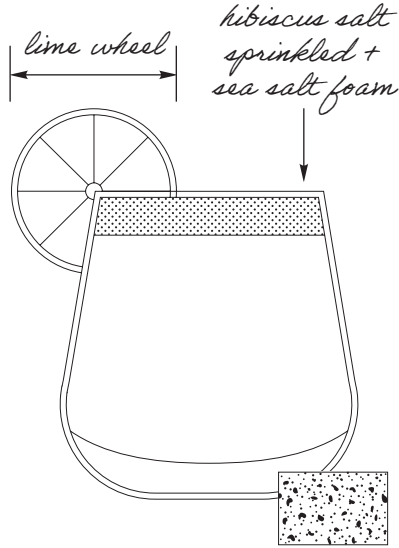

Appleton Estate Signature Blend Rum, Campari, Liber & Co. Pineapple Gum Syrup, fresh lime, pineapple juice



lime wheel

*hibiscus salt
sprinkled +
sea salt foam*

*spiced/smoked version:
tajin rim + chili threads*

ELEMENT KEY	
	Timeless
	Vibrant
	Wellness
	Community
	Sustainable



MARGARITA 16

Patrón Silver Tequila, Italicus Rosolio di Bergamotto, fresh lime, Monin Agave Nectar

Level up with Herradura Reposado 18

Make it spicy with Ancho Reyes Chile Liqueur 18

Try it smoky with Dos Hombres Mezcal 18

CLASSIC MARTINI 17

DRY / STIRRED

The Botanist Gin or Ketel One Vodka, Carpano Dry Vermouth, orange bitters, lemon twist

DIRTY / SHAKEN

Tito's Handmade Vodka, Carpano Bianco Vermouth, house brine, Filthy Foods Olive Accoutrements

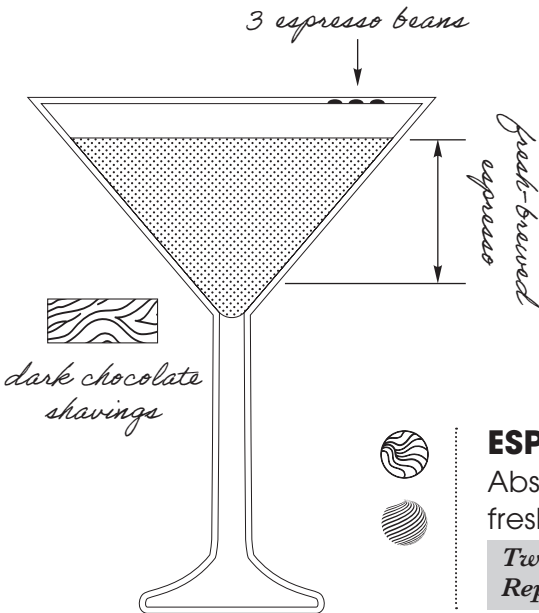
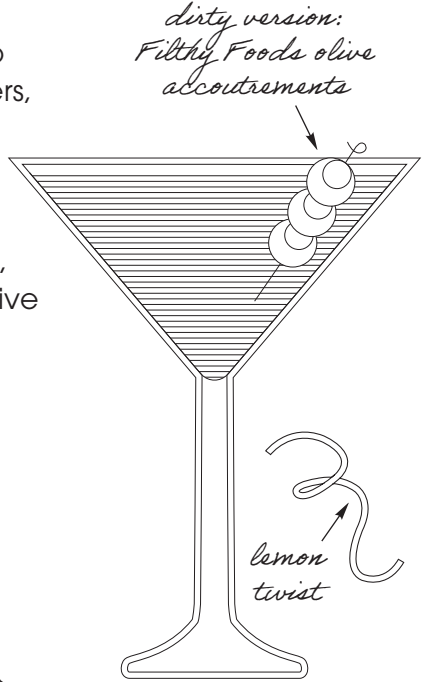

ESPRESSO MARTINI 15

Absolut Vodka, Kahlúa, fresh espresso

Twist it up with Casamigos Reposado Tequila 22

Cocktails

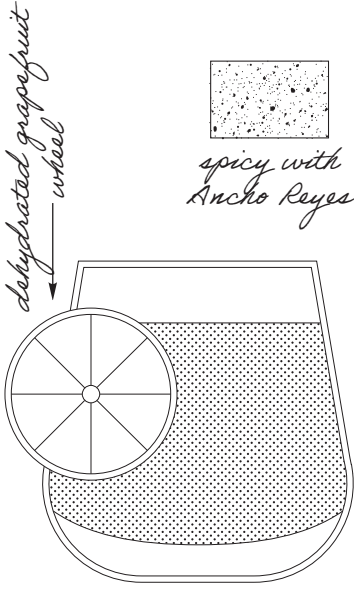

originally called the "De Regueur" in cocktail books

BROWN DERBY 16

Woodford Reserve Bourbon, fresh grapefruit, barrel-aged maple syrup, orange bitters

Spice it up with Ancho Reyes Chile Liqueur 18

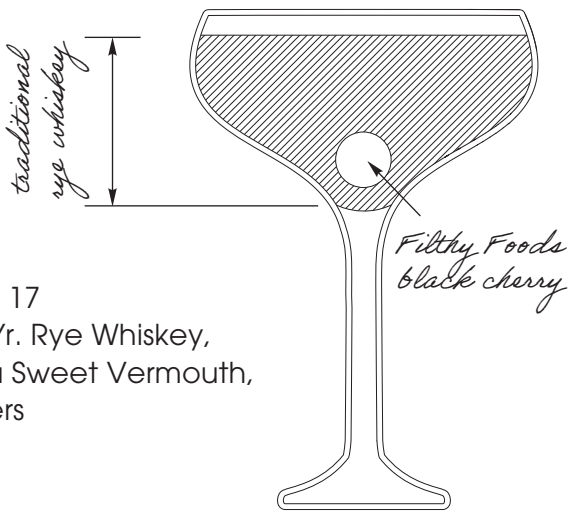

MANHATTAN 17

Knob Creek 7 Yr. Rye Whiskey, Antica Formula Sweet Vermouth, Angostura Bitters



*Filthy Foods
black cherry*

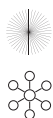
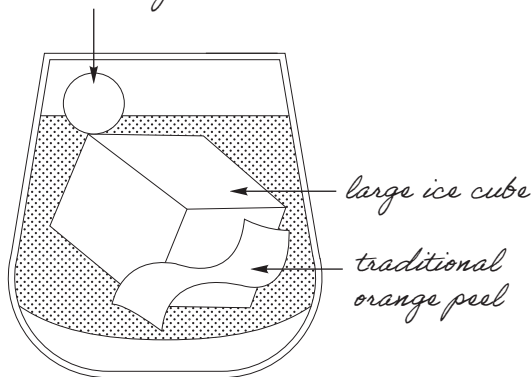





OLD FASHIONED 16

High West Bourbon, Liber & Co Demerara Syrup,
El Guapo Bitters

Level up with Garrison Brothers Small Batch Bourbon 24

Make it a twist featuring Cincoro Reposado Tequila 30

ELEMENT KEY	
	Timeless
	Vibrant
	Wellness
	Community
	Sustainable

Mocktails

candied ginger slice

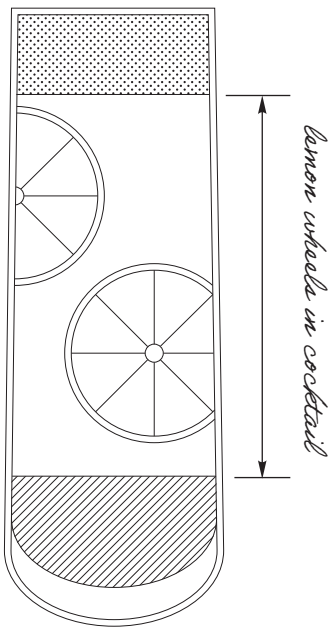

SEAMLESS 12
 Monin Vanilla, Passion Fruit Reàl, fresh lemon, Q Club Soda

dehydrated blood orange wheel



fresh orange zest

ELEMENT KEY	
	Timeless
	Vibrant
	Wellness
	Community
	Sustainable



SILHOUETTE 12
 Seedlip Grove 42, Monin Lemongrass, apple cider vinegar, orange zest

DRAFT

MICHELOB ULTRA 7
DALLAS BLONDE 8
MANHATTAN PROJECT 8
DOS EQUIS 8
MILLER LITE 7
VOODOO RANGER IPA 8

DOMESTIC 7

COORS LIGHT
MILLER LITE
BUDWEISER
SHINER BOCK

IMPORTED 8

STELLA ARTOIS
CORONA EXTRA
MODELO ESPECIAL
DOS EQUIS LAGER
HEINEKEN
PERONI

NON-ALCOHOLIC 7

HEINEKEN 0.0
ATHLETIC BREWING CO.
RUN WILD NA IPA

CRAFT 8

BLUE MOON BELGIAN WHITE
NEW BELGIUM FAT TIRE ALE
YUENGLING LAGER
WILD ACRE JUICE
SLINGER IPA

**HARD SELTZER
& CIDER 8**

WHITE CLAW MANGO
HARD SELTZER
WHITE CLAW BLACK CHERRY
HARD SELTZER
HIGH NOON WATERMELON
VODKA HARD SELTZER
ANGRY ORCHARD
HARD CIDER
HAPPY DAD HARD SELTZER

White Wines

Intensity

Fruit

Tannin

Acidity



LUNETTA • **Prosecco Brut**



CHANDON • **Sparkling Rosé**



MOËT & CHANDON IMPÉRIAL • **Brut Rosé**



CHATEAU STE. MICHELLE • **Riesling**



SANTA MARGHERITA • **Pinot Grigio**



ROSE GOLD • **Rosé**



DECOY BY DUCKHORN • **Sauvignon Blanc**



PINE RIDGE • **Chenin Blanc/Viognier**



KENDALL-JACKSON VINTNER'S RESERVE
Chardonnay

○ Min ● Mid ● Max

White Wines

	6oz	9oz	BTL
Veneto, Italy (187ml)	13	-	-
California (187ml)	21	-	-
Champagne, France (187ml)	-	38	147
Columbia Valley, Washington	12	17	-
Valdadige, Veneto, Italy	18	26	-
Côtes de Provence, France	15	21	-
California	17	24	-
California	12	17	-
California	14	20	-

Red Wines

Intensity

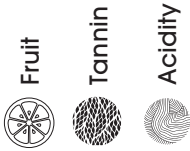

ELOUAN • **Pinot Noir**



BANFI • **Chianti Classico**



BENZIGER • **Merlot**



CATENA VISTA FLORES • **Malbec**



TRIBUTE • **Cabernet Sauvignon**



FRANCISCAN ESTATE CORNERSTONE
Cabernet Sauvignon



JOEL GOTT • **Red Blend**



DAOU • **Cabernet Sauvignon**

Red Wines

	6oz	9oz	BTL
Oregon	15	21	-
Tuscany, Italy	13	18	-
Sonoma County, California	12	17	-
Mendoza, Argentina	13	18	-
California	12	17	-
California	13	18	-
Columbia Valley, Washington	12	17	-
Paso Robles, California	17	-	-

Bar Snacks

BOARDS

BUTCHER'S BOARD 20

assorted cheese & charcuterie, citrus-marinated olives, lavosh crackers

FIG, BRIE & PROSCIUTTO FLATBREAD 22

arugula, balsamic glaze

DIPS

RANCH POTATO CHIPS 5

herb onion dip

TATER KEGS 13

bacon, jalapeño, cheddar, hot honey ranch

LARGER PLATES

CRISPY CHICKEN BITES 15

ranch dip

CHICKEN WINGS 12

asian "buffalo" sauce, scallions, sesame

BRUSCHETTA 12

whipped feta cheese, roasted tomato, fried capers, shaved fennel

GLUTEN-FRIENDLY



VEGETARIAN

VEGAN

Gluten-friendly bread available upon request

*Consuming raw or undercooked meats / poultry / seafood / shellfish or eggs may increase your risk of foodborne illness.

Please notify us of any food allergy.

SNACKS



EDAMAME 9

yuzu kosho, sea salt,



MEATBALLS 15

beef & pork, basil
tomato sauce, grated
parmesan cheese
lemon oil



OLIVES 9

smoked orange peel,
chile de árbol



TX CREAM PUFFS 15

brisket, pimento cheese,
smoked cheddar,
hot honey

SWEETS



**STRAWBERRY
CHEESECAKE
ICE CREAM
SANDWICH** 10

local strawberry milk,
yuzu-strawberry jam,
freeze dried crispies
(contains nuts)



TX COOKIE PLATE 10

seasonal & assorted

ENERGY / WATER

FIZZ

RED BULL ENERGY DRINK 6

RED BULL SUGARFREE 6

TOPO CHICO 6

TOPO CHICO
LIME TWIST 6

S.PELLEGRINO SPARKLING
MINERAL WATER 500ML 5

S.PELLEGRINO ESSENZA 6
assorted flavors

FLAT

ACQUA PANNA 500ML 5

With sincere gratitude we give thanks to our partners who build community and promote sustainability.

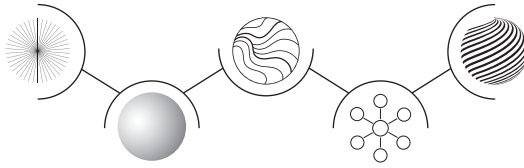

COMMUNITY

Owen's American Tonic: Helping to raise awareness to Fields of Honor in support of families of fallen or disabled military and first responders with more than 35,000 scholarships awarded since 2007.

21 Seeds Tequila: Female-founded infused tequila inspiring you to gather your tribe of friends new and old, cross borders, share ideas, and make connections.

Appleton Estate Rum: In 1997, Dr. Joy Spence became the first woman appointed master blender in the industry, an amazing milestone for women across the world!

Woodford Reserve Bourbon: Woodford Reserve works closely with Old Friend Farms, where racing thoroughbreds are sent to retire and raise awareness of the importance of equine aftercare.

High West Bourbon: Pledged \$1,000,000 over the next three years to organizations that are working to protect the West from wildfires – including Wildland Firefighter Foundation, Protect Our Winters (POW), and American Prairie Reserve.

Monin: Honored to partner with organizations making a positive impact including Grounds for Health, Children of Restaurant Employees (CORE), and Step Up for Students.



SUSTAINABILITY

Patrón Tequila: Patrón was the first distillery to install a natural gas pipeline, which acts as its main energy source and helps reduce CO2 emissions in the atmosphere.

Absolut Vodka: For the past four years, Absolut has been using so-called waste spirits to reduce use of liquefied propane gas (LPG) to generate energy at their Nöbbelöv distillery.

Seedlip: Seedlip is a 1% for the Planet member, giving 1% of global annual revenues to environmental charities dedicated to celebrating and protecting the planet.